

FITMENT INSTRUCTIONS

Alu-Cab™



Khaya To Tacoma Gen 2 & 3 (SB & LB)

All rights reserved. No part of this document may be reproduced, translated, stored in a retrieval system, or transmitted, in any form or by any means, electronic, mechanical, photocopying, recording or otherwise, without prior written permission of the owner.

Review all instructions information carefully before installation.

Any damages, direct or incidental to the installer and/or property due to incorrect installation of any parts are the responsibility of the installer. Due to the various applications and fitment options available, the responsibility lies with the user to ensure all mounting points are secure and tight before every trip. If unsure, consult with your Distributor regarding the operations of our products.

Users are advised to be mindful of the load they are carrying and drive in accordance with road conditions.

DISCLAIMER

Alu-Cab

1. Khaya Fitment – Tools, Fasteners & Materials

The tables below show the equipment, i.e. tools and fasteners required to mount the Khaya onto a Gen 2, Gen 3, SB & LB pick-up.

1.1. Tools & Items Required:

TOOLS
Ratchet
Allen key
19mm Socket
19mm Ring Flat Spanner
17mm Socket
17mm Ring Flat Spanner
Drill and 12.5mm drill bit

1.2 Fasteners supplied:

ITEM	QUANTITY
M12 Flat Washer	8off
M12 8 LINK CHAIN	4off
M12 Eye bolt	4off
M12 rigging screw	4off
M12 Nyloc nut	4off
SPACER BOARD	2 off
M10 D-shackle	8 off
M12x35 Hex bolt	4 off

1.3 Hardware Supplied:

ITEM	QUANTITY
132-TAC-SB-FRONT-MOUNT (10mm mild steel)	1off
132-REAR-TOW-PLT-01-00 (10mm mild steel)	1 off
132-RER-FRA-LOW-MNT-PLT-01-00 (4.5mm 316 ss)	4 off



WARNING

Always wear appropriate PPE (Personal protection equipment) when fitting this product. Although the mounting kit is designed to be DIY, if you have any doubts or concerns, contact an accredited fitment centre to carry out the work. Alu-Cab will not be liable for any injury to persons, and/or damage to products and/or vehicles.

2. Front Fitment

A. Fitting to SB & LB

Use the two holes located at the front of the load bed to mount the front mounting plate

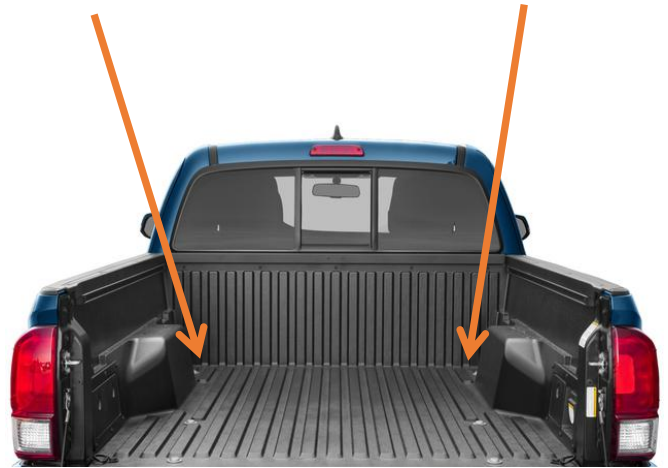
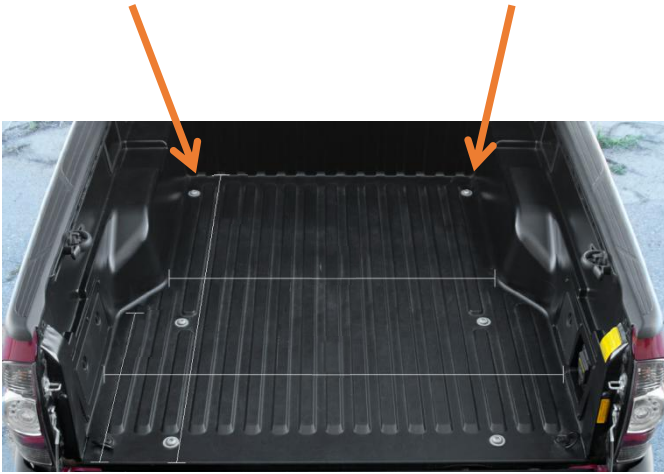

SHORT BED (SB)

LONG BED (LB)

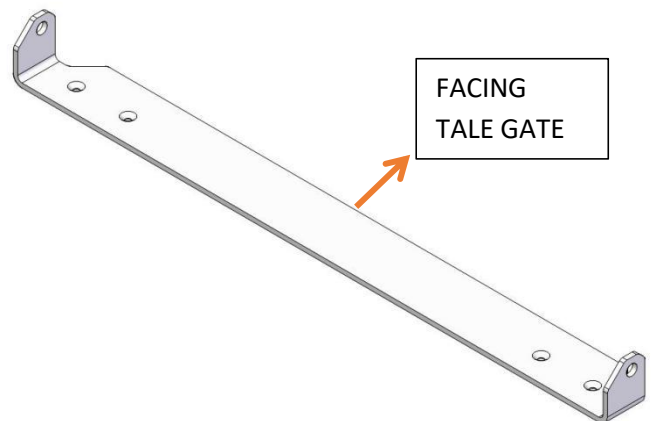
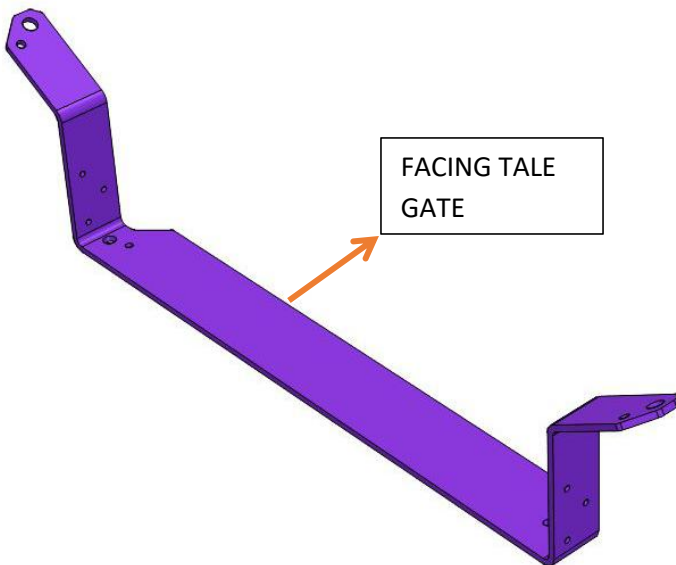

SB FRONT MOUNT

LB FRONT MOUNT

Front Fitment-continued

B. Fitting to SB & LB

The images below will illustrate how the chain mounting assembly setup would be fitted to **SB & LB** front mounting bracket.

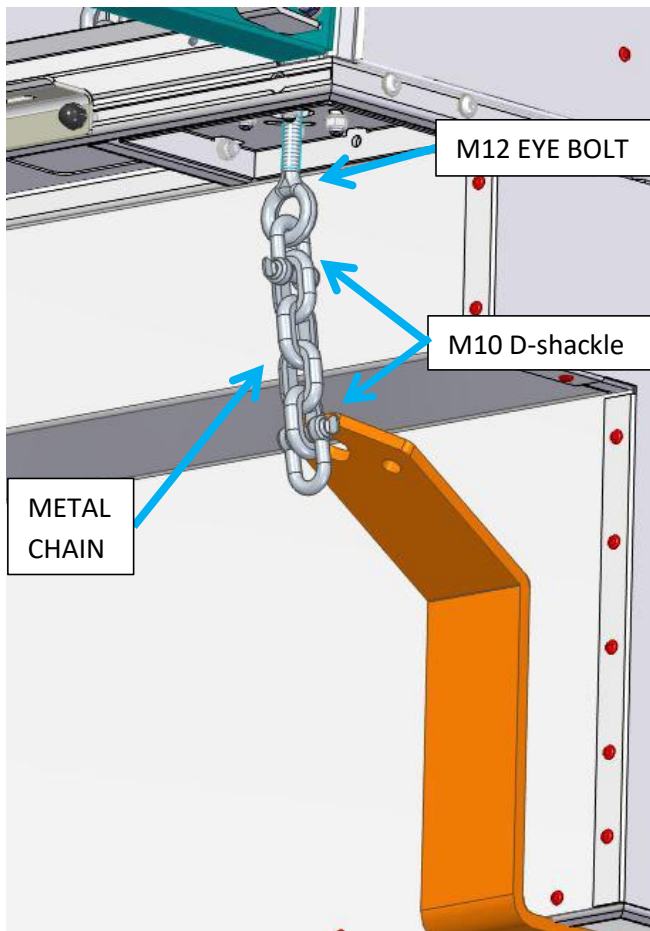

SB FRONT MOUNT ASSEMBLY

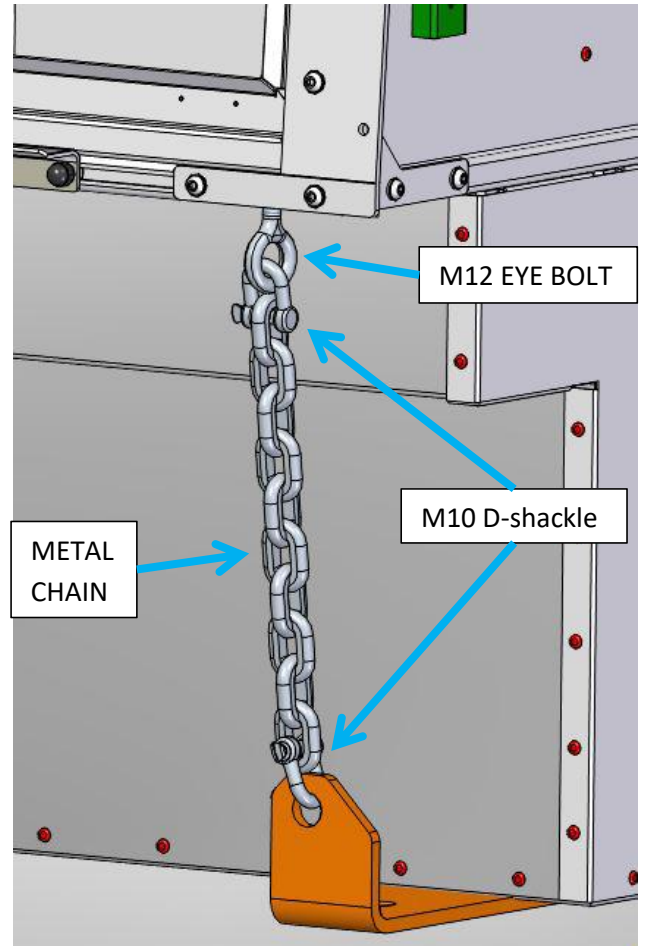

LB FRONT MOUNT ASSEMBLY

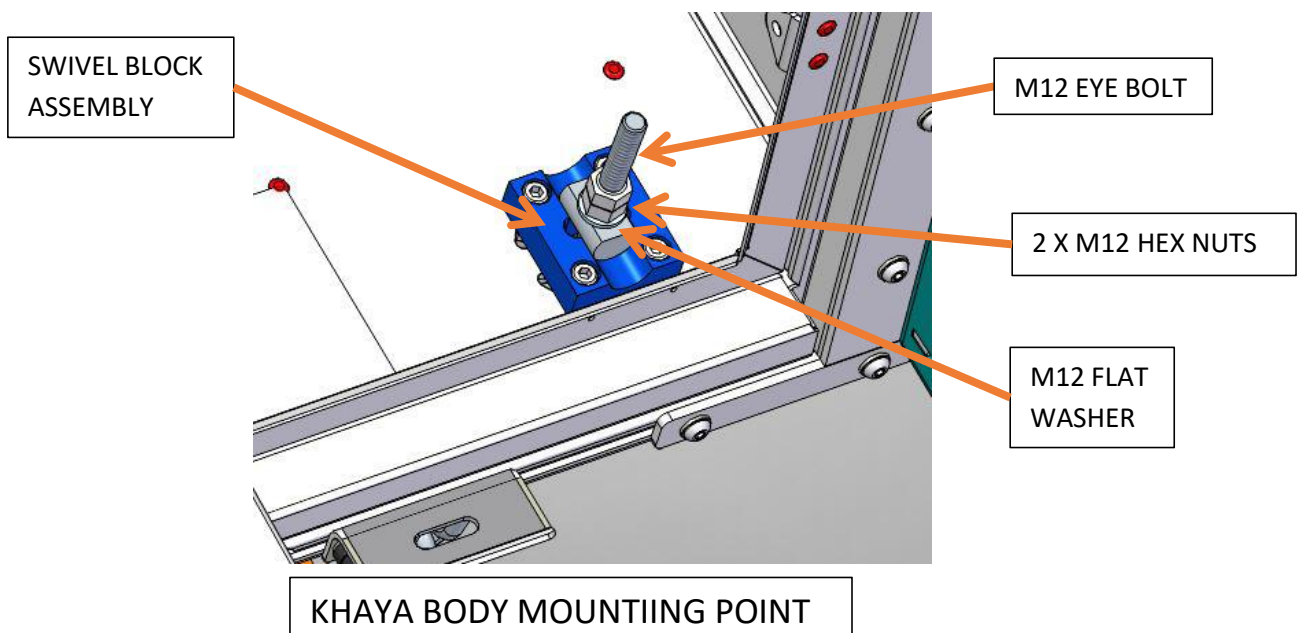

3. REAR FITMENT

A. FITTING TO LB:

Use the holes shown below to mount the rear mounting plate to the load bed.

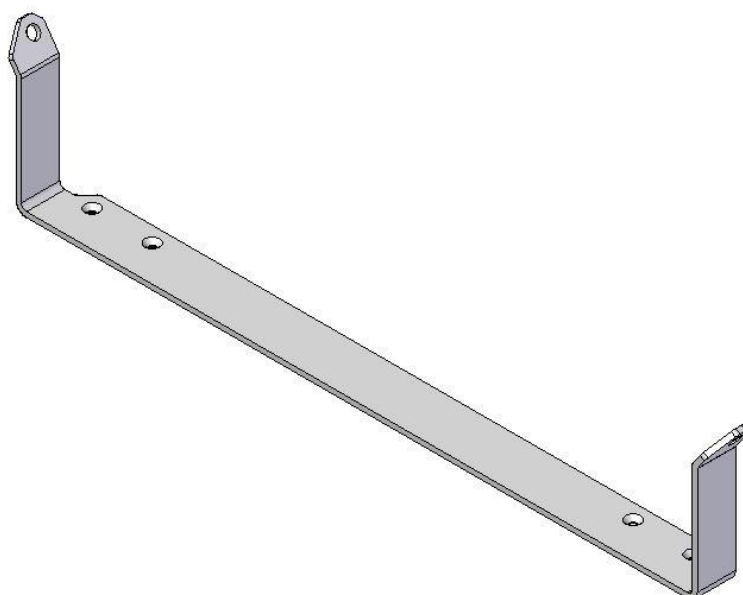

LB REAR MOUNT

B. FITTING TO SB:

The rear mounting brackets are pre-fitted to the Khaya. Remove the tow bar bolts and fit the tow bar plate supplied. Fit the two eye bolts and fasten with a washer and M12x35 hex bolt supplied. Tie down the camper with the RIGGING SCREW assembly as shown below.

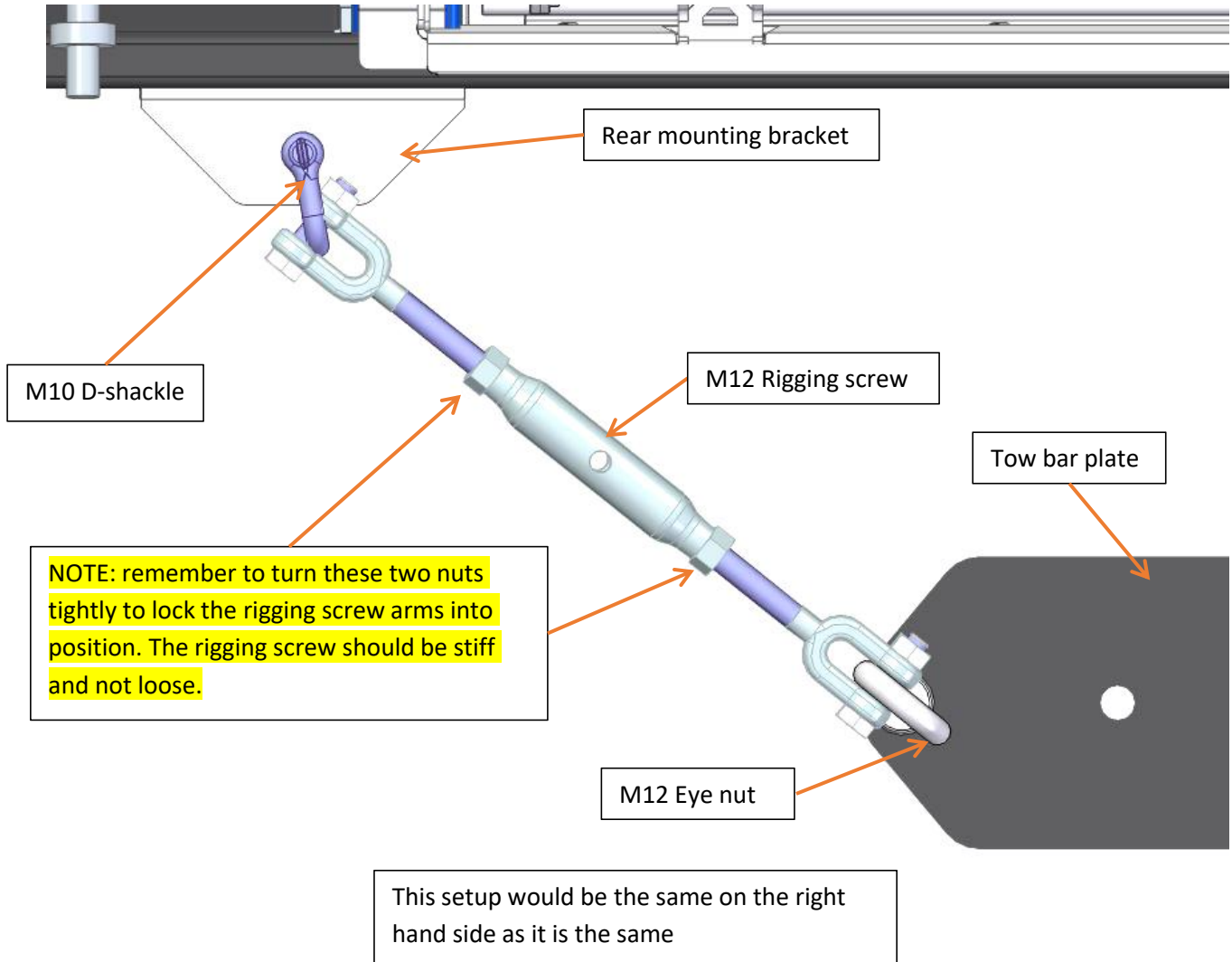

NB: In some cases there may be a metal chain in the rigging screw assembly to accommodate for Length variants.